

GOJO LTX-7™ DISPENSER DIMENSIONS

These dimensions apply to GOJO®, PURELL®, PROVON® and MICRELL® brand LTX-7 dispensers.

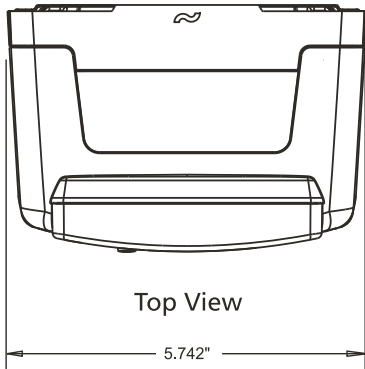

Use the dimensions provided to ensure adequate wall spacing and clearance for the unit.

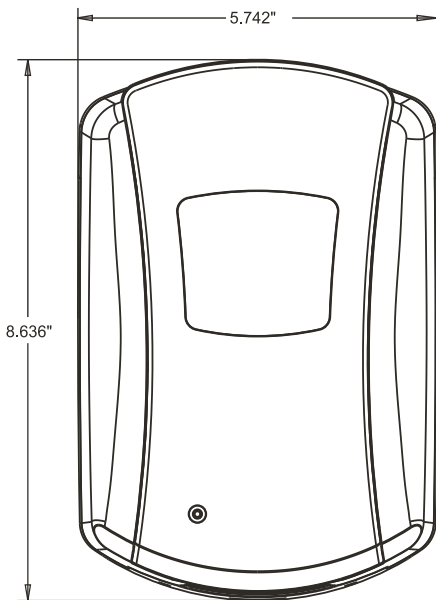

Front View

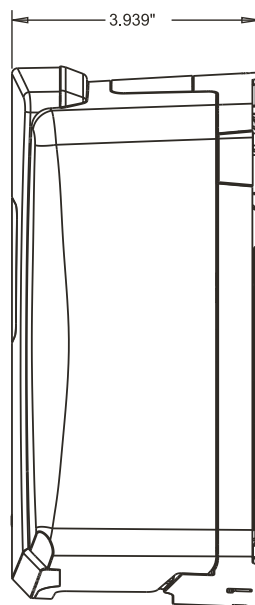

Side View

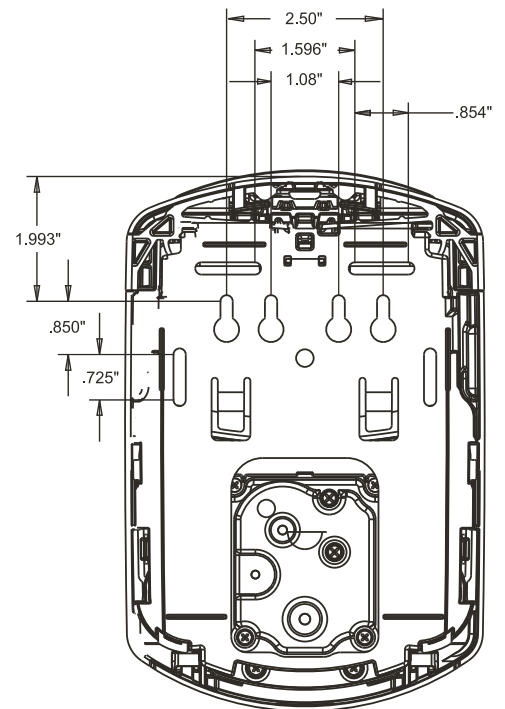

Back View



GOJO Industries, Inc.
One GOJO Plaza, Suite 500
P.O. Box 991 • Akron, OH 44309-0991
Tel: 1-330-255-6000 • Toll-free: 1-800-321-9647
Fax: 1-800-FAX-GOJO